

# Ulusoy URING36 C - SF<sub>6</sub> Insulated Incoming&Outgoing RMU Switchgear with Vacuum Circuit Breaker User Manual



**EATON**

*Powering Business Worldwide*

# CONTENTS

SWITCHGEAR INTRODUCTION & DIMENSIONS

CHECKS BEFORE POWERING

MIMIC PANEL AND PROTECTION ASSEMBLY BOARD

POSITIONS AFTER ASSEMBLY

POWERING THE SWITCHGEAR : TURNING THE EARTHING DISCONNECTOR ON

POWERING THE SWITCHGEAR: TURNING THE DISCONNECTOR OFF -  
TURNING THE BREAKER OFF

BREAKING THE POWER OF THE SWITCHGEAR: TURNING THE BREAKER ON

BREAKING THE POWER OF THE SWITCHGEAR: TURNING THE DISCONNECTOR  
ON AND TURNING THE EARTHING DISCONNECTOR OFF

REPLACING THE VOLTAGE INDICATOR AND ELECTRIC TERMINAL SCHEME

TROUBLESHOOTING

# GENERAL INTRODUCTION

1	LOW VOLTAGE BREAKER LOCK
2	LOW VOLTAGE BREAKER ON-OFF BUTTONS
3	BREAKER SPRING STATUS INDICATOR
4	RELAY
5	CLOSING SPRING ASSEMBLY HOUSING
6	DISCONNECTOR SAFETY LOCK
7	ON OFF BUTTONS
8	CELL FRONT COVER
9	EARTHING DISCONNECTOR ASSEMBLY HOUSING
10	ELECTRICAL CONTROL BUTTONS
11	SIGNAL LIGHT BOX
12	REMOTE CONTROL SOCKET
13	VOLTAGE INDICATOR LIGHTS
14	LOW VOLTAGE BREAKER SPRING ASSEMBLY HOUSING

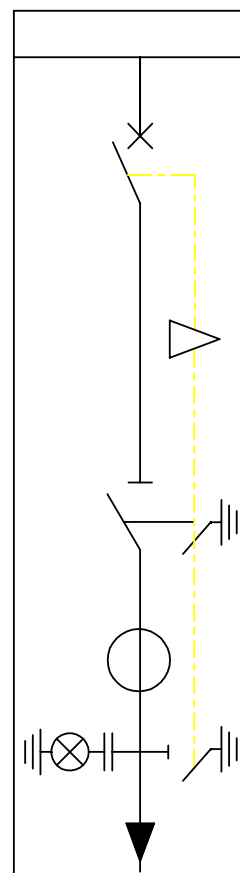
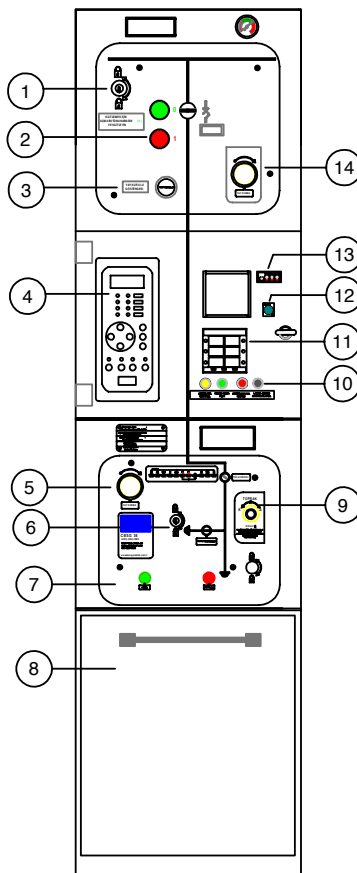

SINGLE LINE SCHEME

## DIMENSIONS (in millimeters)

1	LOW VOLTAGE CUTTER
2	LOW VOLTAGE CABIN
3	MECHANISM SECTION
4	HEAD CONNECTION TERMINAL
5	CABLE CONNECTION CLAMPS
6	BAR CONNECTION TERMINALS

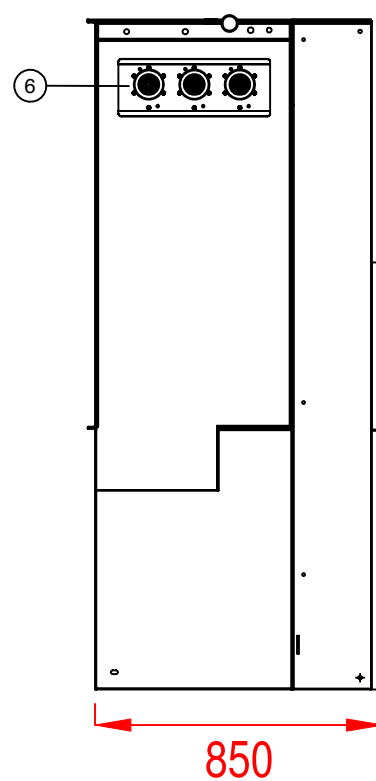
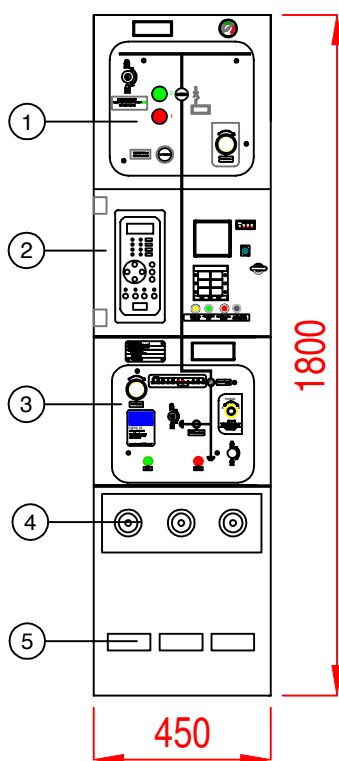

## Checks Before Powering

Check if there are foreign objects in the cells.

Check the connections of the cells.

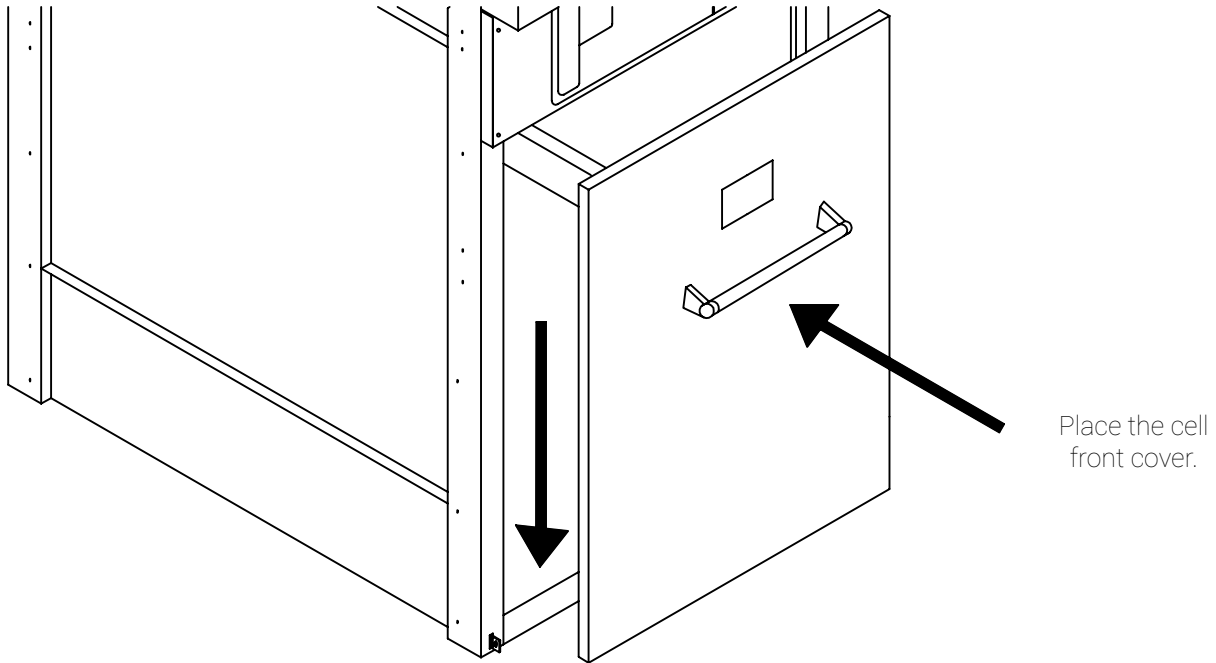

Check if the front cover is placed correctly.

If the front cover is not fixed, assemble lever cannot be placed in spring assembly housing.

## Phase Conformity Test

Voltage indicator

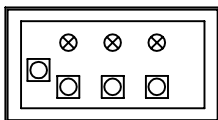

### Input Cell:

When input cables are powered, voltage indicator lights must be on.

### Output Cell:

When the disconnecter and breaker are off, voltage indicator lights must be on.

### Cable Test

In Output Cells To check cable faults.

- Turn the breaker on.
- Turn the disconnecter on.
- Turn the earthing disconnecter off.
- Open the cell front cover.
- Place the cable test device.
- Turn the earthing disconnecter on.
- Perform the required measurements.

Serial light

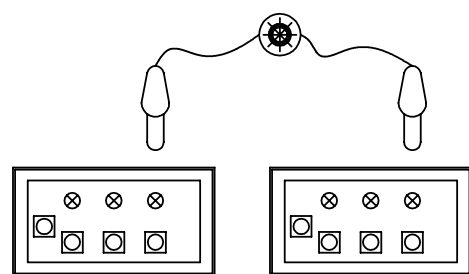

If the phases conform, light is off.  
If the phases do not conform, light is on.  
( Test device cannot be delivered with cells.)

In Input Cells To check cable faults.

- Turn the breaker on.
- Turn the disconnecter on.
- Break the power of the cell from previous center and perform the earthing of the cables.
- Turn the earthing disconnecter off.
- Open the cell front cover.
- Place the cable test device.
- Turn the earthing disconnecter on from both sides.
- Perform the required measurements.

# MIMIC PANEL

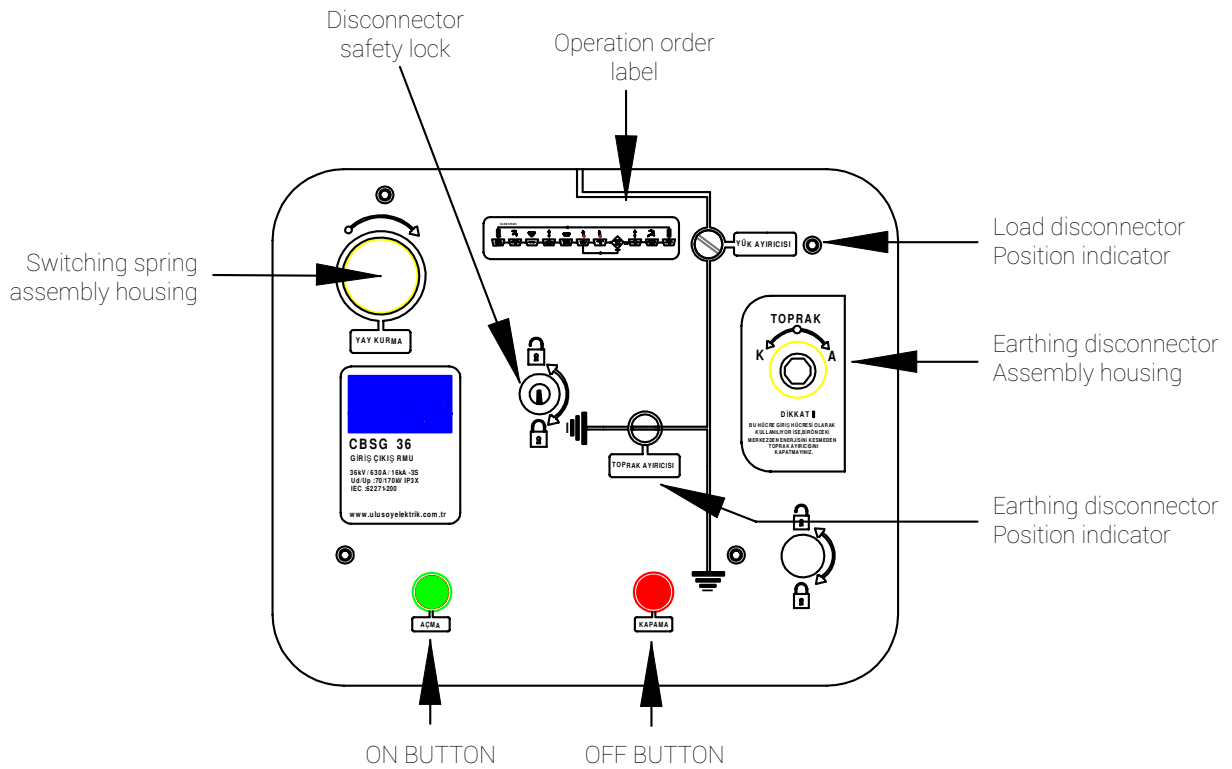

# PROTECTION AND CONTROL BOARD

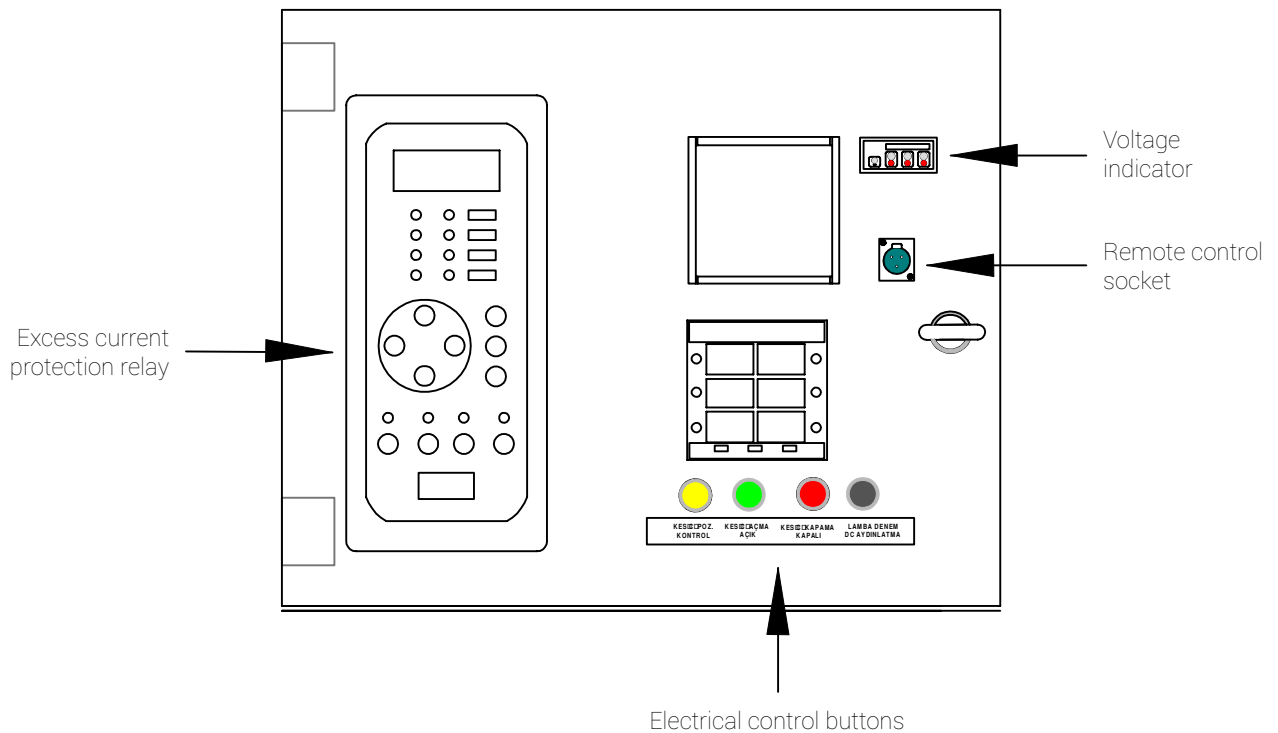

# MIMIC PANEL

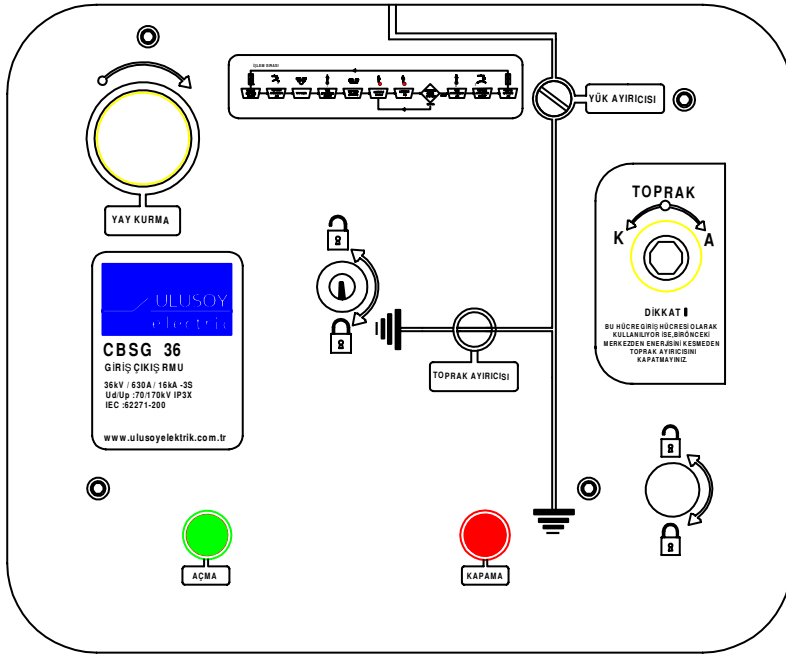

**At the beginning after the assembly works are finished;**

Earthing disconnector is off, disconnector is on, cell front cover is open.

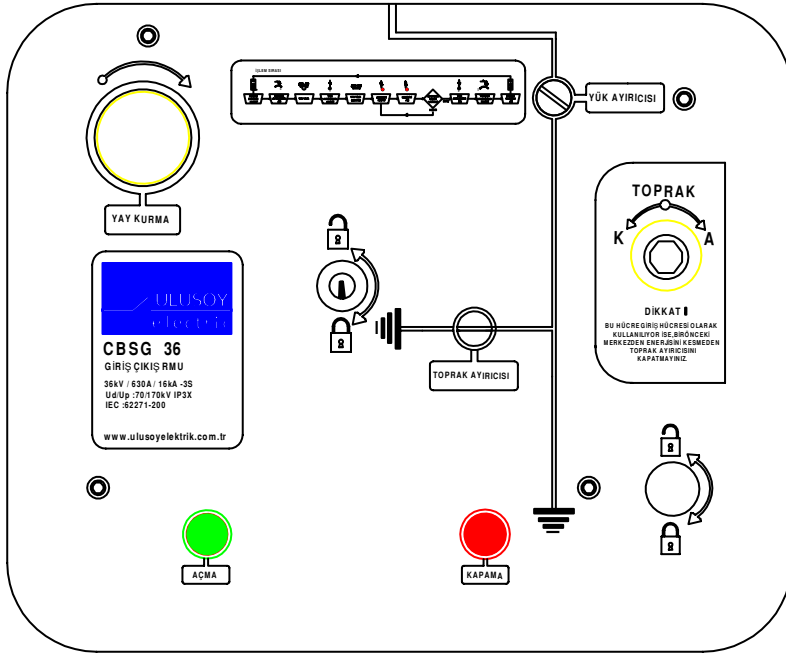

**After closing the cell front cover;**

Earthing disconnector is off, disconnector is on, cell front cover is closed.

# POWERING THE SWITCHGEAR

## Starting conditions:

Earthing disconnector is **off**, disconnector is **on**, disconnector key safety lock is on, breaker **on** and **locked**, front cover is **placed**.

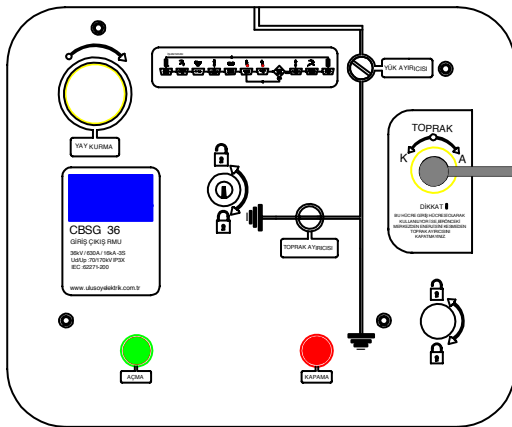

### Turning the earthing disconnector on:

Place the assembly lever into the earthing disconnector assembly housing as shown in the figure, rotate it in arrow direction and turn the earthing disconnector on.

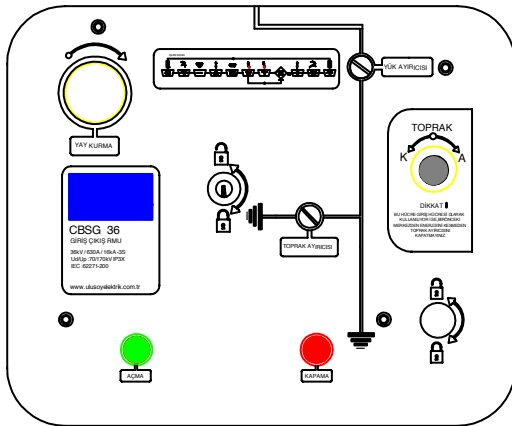

### After turning on the earthing disconnector:

Earthing disconnector is on, disconnector is on, breaker is on.

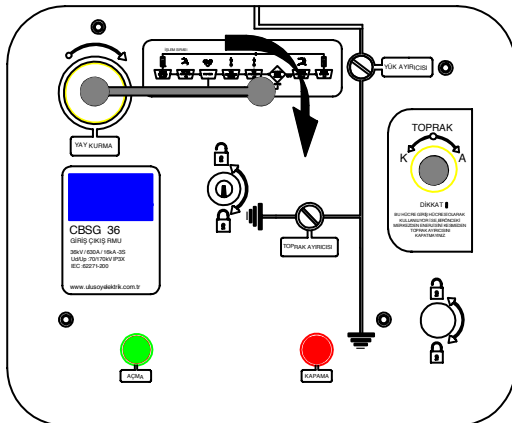

### Assembling the disconnector closing spring:

Place the assembly lever into the closing spring housing, rotate in arrow direction and assemble the spring.

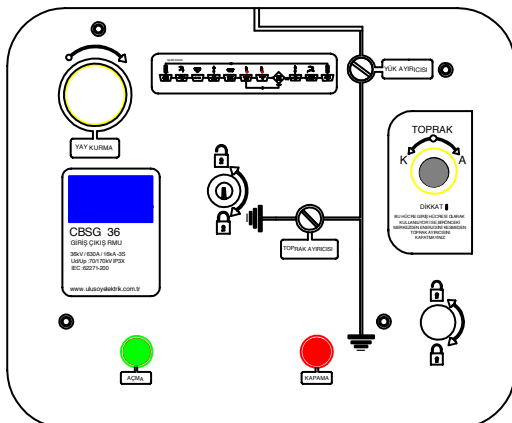

### After assembling the disconnector closing spring:

Earthing disconnector is on, disconnector closing spring is assembled, breaker is on, key disconnector safety lock is on.

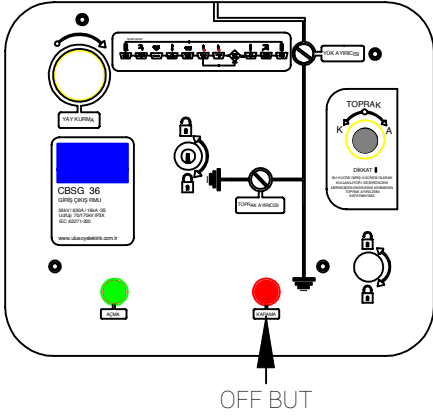

**Turning the disconnecter off:**

Press the off button to turn the disconnecter off.

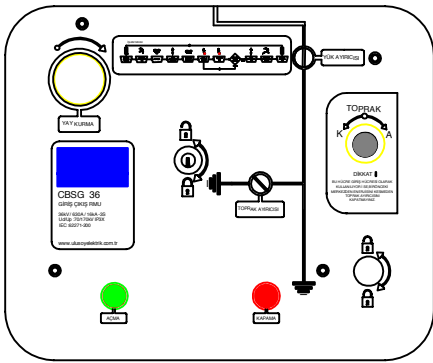

**After turning the disconnecter off:**

Earthing disconnecter is on, disconnecter closing spring is assembled, breaker is on, key disconnecter safety lock is on.

**Turning the breaker off**

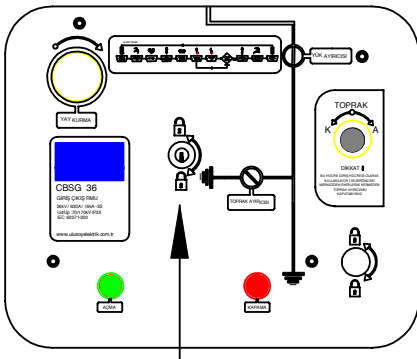

Lock the disconnecter on-off buttons by rotating key disconnecter safety lock and key to the right.

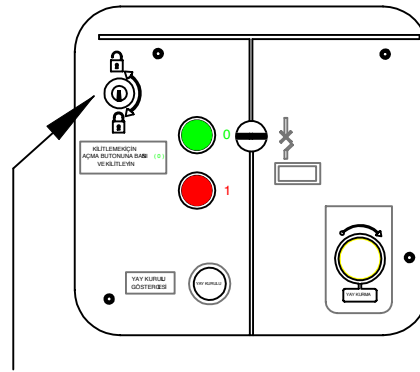

Remove the key from disconnecter safety lock and assemble it to breaker key safety lock. Open the breaker lock and assemble the closing spring with assembly lever. If auxiliary supply voltage connection is done, it shall automatically be assembled with closing spring assembly engine when low voltage fuses are turned off.

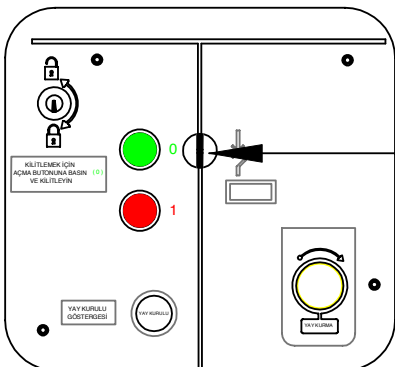

Breaker off button

Turn the breaker off by pressing the off button on breaker control mechanism or breaker off button on protection control board. Thus the cell is powered.



# BREAKING THE POWER OF THE SWITCHGEAR

## Starting conditions:

Disconnecter is off, breaker is off.

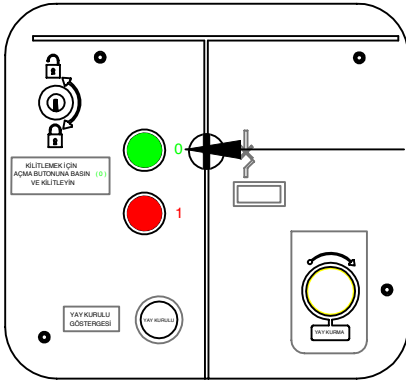

Breaker  
on  
button

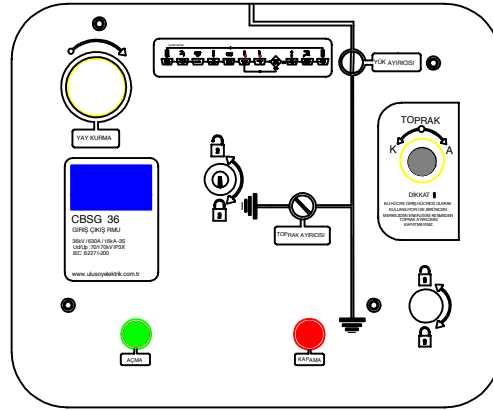

## To turn the breaker on:

Turn the breaker on by pressing the on button on breaker control mechanism or breaker on button on protection control board.

Breaker key Safety lock

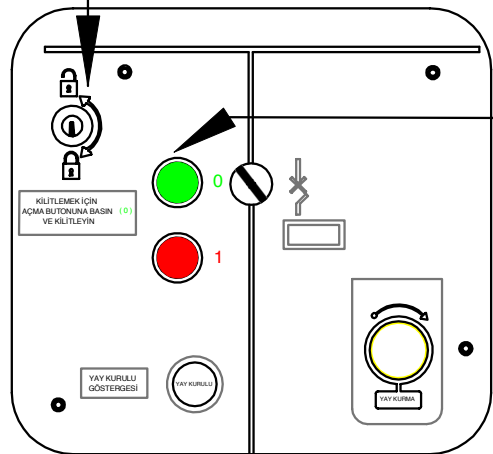

Breaker  
on  
button

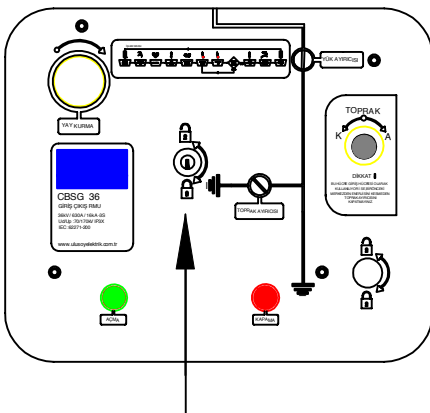

Press the breaker on button and lock the key safety lock and breaker in on position at the same time and remove the key.

Insert the key you remove from breaker safety lock to disconnector safety lock, rotate it to the left to unlock the disconnector on-off buttons.

## Disconnecter maneuvers

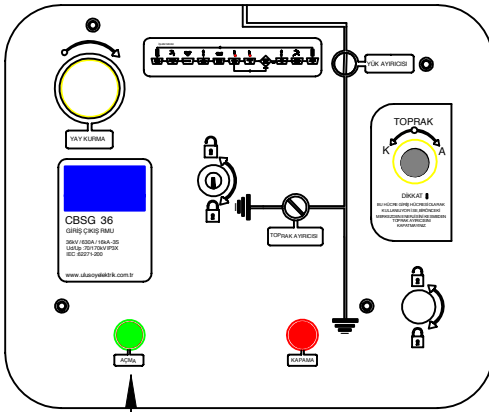

### Turning the disconnecter on:

Press the on button to turn the disconnecter on.

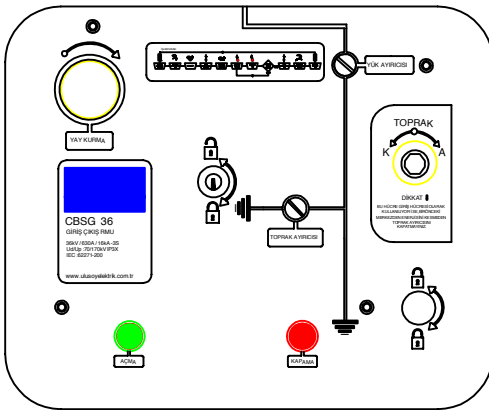

### After turning the disconnecter on:

Earthing disconnector is on, disconnecter is on, key disconnecter safety lock is open.

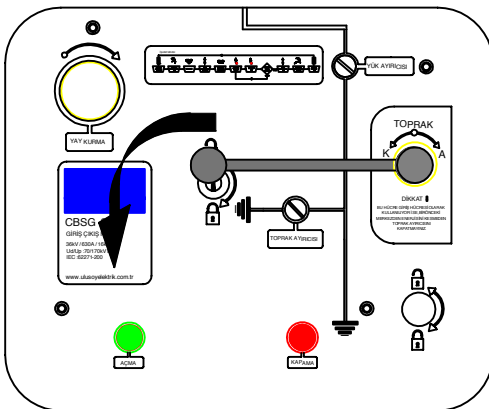

### Turning the earthing disconnector off:

Place the assembly lever into the earthing disconnector assembly housing and turn off the earthing disconnector by rotating in arrow direction.

### If the cell is an input cell:

Check if the energy is broken from previous center before turning the earthing disconnector off.

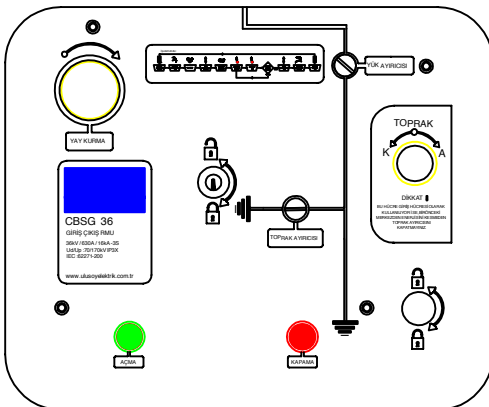

### After turning off the earthing disconnector:

Earthing disconnector is off, disconnecter is on, **Now the cell front cover may be removed.**

# ELECTRIC TERMINAL SCHEME

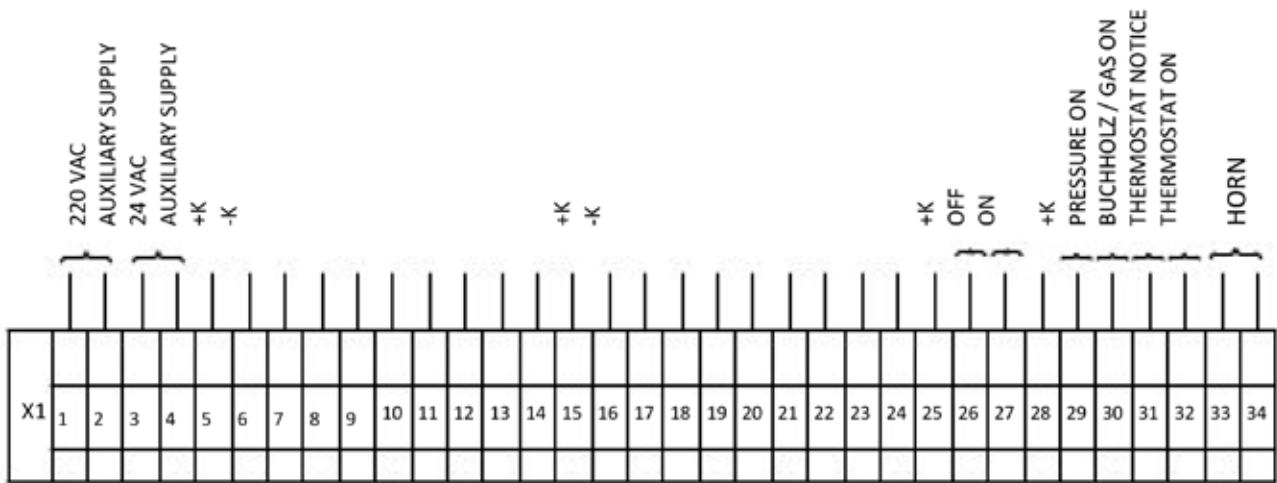

# REPLACING THE VOLTAGE INDICATOR

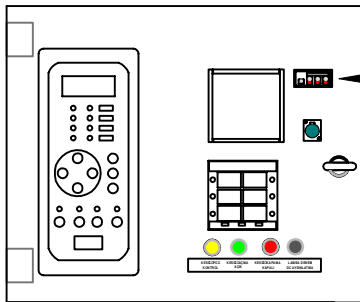

## To replace a faulty voltage indicator;

Open the front cover of low voltage assembly board of the cell Remove the faulty indicator by dismantling its latches and replace it with a new one. This procedure can be performed when the cell is supplied with power.

# TROUBLESHOOTING

<p><b>Voltage indicator Light / lights are off.</b></p>	<p>Voltage indicator light / lights are blown. Voltage indicator connection cable socket may be fallen off. For output cell : Check if the disconnecter and the breaker are off. For input cell: There is no voltage in medium voltage input cables.</p>
<p><b>Cell front cover cannot be turned on or off.</b></p>	<p>Check if the earthing disconnecter is off. If on, turn off.</p>
<p><b>Earthing disconnecter cannot be turned on.</b></p>	<p>Check if the cell front cell is correctly placed. Remove the cell front cover and turn the earthing blade on and off a few times while the cover is open.</p>
<p><b>Disconnecter cannot be turned off.</b></p>	<p>Check if the earthing disconnecter is on.</p>
<p><b>Disconnecter cannot be operated electrically.</b></p>	<p>Check if low voltage connections are done. Check if low voltage fuses are off. Check if the key safety lock is on. Check if DC auxiliary supply source is charged or not. Check the polarity of the connection made for DF supply source.</p>
<p><b>Breaker spring assembly engine is not working.</b></p>	<p>Check if low voltage connections are done. Check if low voltage fuses are off. <b>If the engine is DC supplied :</b> Engine DC supply source must be separate from assembly supply. Check if DC auxiliary supply source is charged or not. Check the polarity of the connection made for DF supply source.</p>

Eaton's mission is to improve the quality of life and the environment through the use of power management technologies and services. We provide sustainable solutions that help our customers effectively manage electrical, hydraulic, and mechanical power - more safely, more efficiently, and more reliably.

Eaton's 2019 revenues were \$21.4 billion, and we sell products to customers in more than 175 countries. We have approximately 95,000 employees.

For more information, visit [Eaton.com](http://Eaton.com)

**Ulusoy Elektrik Imalat Taahhut ve Ticaret A.S.**

1.OSB Oguz Cad. No:6 Sincan

Ankara, 06935 TURKEY

Tel: +90 312 267 07 12

Fax: +90 312 267 05 17

info.ulusoy@eaton.com

www.ulusoyelektrik.com.tr

www.eaton.com



© 2020 Eaton  
All Rights Reserved  
May 2020

Eaton is a registered trademark.

All other trademarks are property  
of their respective owners.